

SPHERE-STAR™ LED WALL WASHER

SPECIFICATION SHEET

- Aluminum body & tempered glass
- IP65 wet/outdoor
- 180° rotary angle
- Wall and ceiling mountable.
- DMX-512 controllable

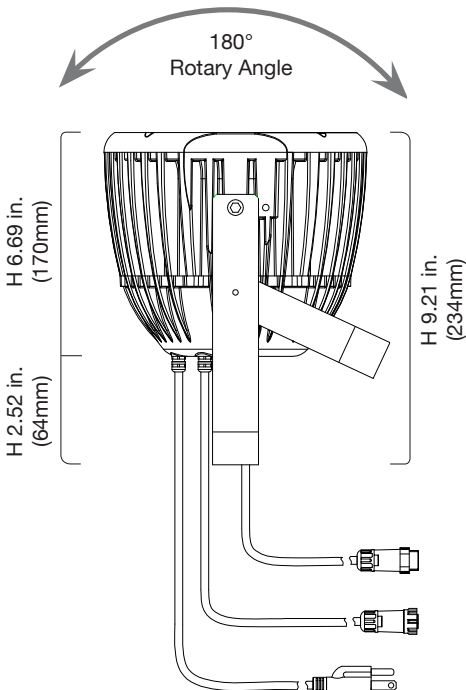
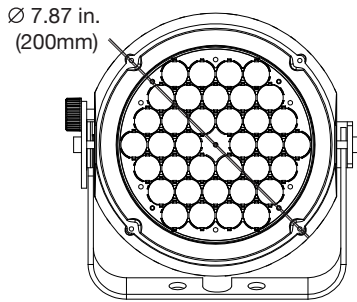

SPECIFICATIONS

Input Voltage ¹: 100-256VAC, 50/60Hz
Power Connection: AC power plug (56 in. length)
Operating Voltage: 24V DC
Power Consumption: 53.5W
LED Chip Type: Edison
LED Chip Beam Angle: 15°
CRI: 70 (6000K)
Mounting ²: Removable rotary 180° surface-mount bracket w/ (3x) 1/2 in. mounting holes
 Wall & ceiling mountable
Maximum Run: 10 fixtures (expandable with use of 8-Way DMX Splitter)
Connections: 1ea. male/female wet location 3-pin M14 cables (15 in. length). M14-to-XLR-3 adapter cables also included

Dimmable ³: May be dimmed/controlled using on-board controls or with a compatible DMX-512 controller
Ambient Temp ⁴: -4° ~ 104° F (-20° ~ 40° C)
Operating Temp ⁵: -4° ~ 131° F (-20° ~ 55° C)
Housing / Cooling: Aluminum casing; tempered glass / cooling by free air convection
Environment ⁶: IP65 wet/outdoor
Dimensions ⁶: 7.87 x 9.21 in. (DIA x H)
Weight: 8.82 lbs.
Certifications: UL Listed (US & Canada) ANSI/UL 153, ANSI/UL 8750 - Light Emitting Diode Luminaires, Portable. E466305

Item #	CCT (Kelvin)	Lumens ⁷	LED Chips	Efficacy ⁸ (lm/W)
DI-0471	-	1326	R=12, B=12, G=12	24.8
DI-0475	6000K	2467	36	45.9

- Note** ¹ Only UL Listed for connection with a 120VAC, 15- or 20-ampere branch circuit.
Note ² When mounting to walls and ceilings, use applicable lag bolts and consider the strength of these surfaces versus the weight of the fixture.
Note ³ Not compatible with standard High Voltage AC dimming controls.
Note ⁴ Do not install product in an environment outside the listed ambient temperature. Ensure adequate airflow and heatsinking is considered when mounting/installing. Exceeding the maximum ambient temperature may damage LED chips by reducing the total lamp life, lumen output, and/or adversely impact color consistency.
Note ⁵ Operating temperature is measured according to the minimum and maximum ambient temperature environment.
Note ⁶ When installing outdoors or in a damp location, ensure water-resistant end caps are connected to all wet location 3-pin M14 cables. If attaching XLR-3 DMX adapter cables seal all standard XLR-3 connections with 1.25" heat shrink and finish with waterproof tape (not included). Do not use liquid sealants of any kind.
Note ⁷ Lumen value measured in accordance to IES LM-79-08. LED chips have a luminous flux range with a tolerance of +/- 5%.
Note ⁸ Efficacy value referenced from IES LM-79-08.

Item #:	Project:
---------	----------

SPHERE-STAR™ RGB

DI-0471

POLAR CANDELA DISTRIBUTION GRAPH

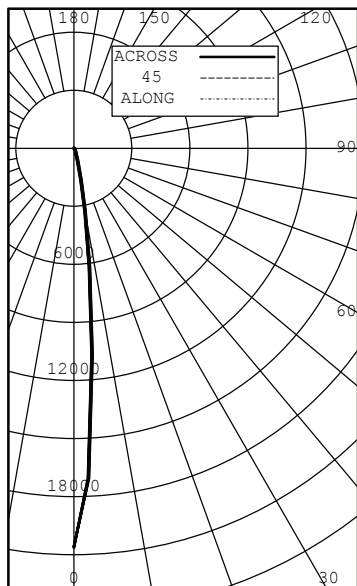

INTENSITY (CANDLEPOWER) SUMMARY
BEAM SIDE

ANGLE	MEAN CP
0	20599
5	10699
10	3326
15	899
20	367
25	231
30	163
35	87
40	55
45	41
50	29
55	20
60	14
65	9
70	6
75	3
80	1
85	0
90	0

ZONAL LUMENS AND PERCENTAGES

ZONE	LUMENS	% LUMINAIRE
0-30	1206	90.92
0-40	1264	95.31
0-60	1314	99.06
0-90	1326	100.00
40-90	62	4.69
60-90	12	0.94
90-180	0	0.00
0-180	1326	100.00

Cone Of Light Tabulation

Mounting Height (Feet)	Footcandles at Nadir	Diameter (Feet)
4.00	1290	0.721
6.00	572	1.08
8.00	322	1.44
10.0	206	1.80
12.0	143	2.16
14.0	105	2.52
16.0	80.5	2.89

SPHERE-STAR™ 6000K

DI-0475

POLAR CANDELA DISTRIBUTION GRAPH

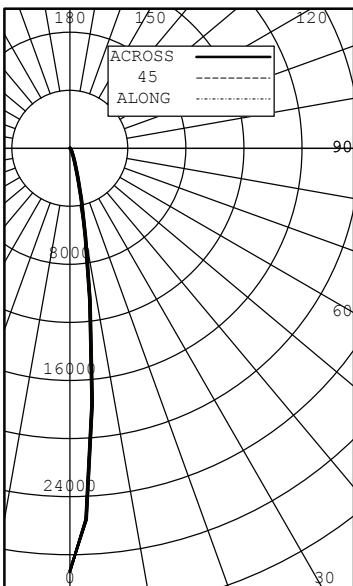

INTENSITY (CANDLEPOWER) SUMMARY
BEAM SIDE

ANGLE	MEAN CP
0	29138
5	17625
10	6197
15	2158
20	918
25	470
30	285
35	192
40	136
45	99
50	68
55	45
60	30
65	21
70	13
75	7
80	2
85	0
90	0

ZONAL LUMENS AND PERCENTAGES

ZONE	LUMENS	% LUMINAIRE
0-30	2198	89.10
0-40	2320	94.07
0-60	2438	98.84
0-90	2467	100.00
40-90	146	5.93
60-90	29	1.16
90-180	0	0.00
0-180	2467	100.00

Cone Of Light Tabulation

Mounting Height (Feet)	Footcandles at Nadir	Diameter (Feet)
4.00	1820	0.842
6.00	809	1.26
8.00	455	1.68
10.0	291	2.11
12.0	202	2.53
14.0	149	2.95
16.0	114	3.37

* Photometric data complies with LM-79-08, ANSI C82.77-02.

DMX CONTROLLERS











The following DMX Controllers may be utilized with our DMX fixtures and accessories.

Item #	Type	Description	Image
DI-1917	DMX Wi-Fi Wall-Mount Controller	This simple and intuitive DMX controller commands up to four zones with WiFi connectivity to a mobile device.	
DI-1726	Nicolaudie STICK 1 DMX Color Controller	Our most sophisticated unit offers professional-grade DMX512 control in a user-friendly control pad.	
DI-1720	Nicolaudie STICK 2 DMX Color Controller	Sophisticated and modern touch-sensitive keypad selects mode, speed, and dimming.	
DI-1727	Nicolaudie Easy Stand Alone DMX LED Color Controller	Program lighting scenes from a computer to the independent free-standing controller.	
DI-1808-K	SQUARE-PRO Junction Box	Included with the following controllers: DMX WiFi Wall Mount Zone LED Controller, Nicolaudie STICK 1 Controller, and Nicolaudie STICK 2 Controller. Also sold separately. Features 3x 0.5 in. and 5x 0.75 in. knockouts. Dimensions: 2.83 x 1.89 x 2.83 (L x D x H)	

Note: accessories sold separately

DMX ACCESSORIES

The following DMX Accessories may be utilized with our DMX fixtures and controllers.

Item #	Type	Description	Image
DI-1918	DMX 4-Channel Decoder	Pair with a DMX controller to control solid color, RGB, and RGBW LED fixtures. Features a digital display for easy addressing.	
DI-0820 (female) DI-0821 (male)	Wireless DMX Transmitter/Receiver	Wirelessly connects DMX devices: Fixture to fixture, fixture to controller, and decoder to decoder. Features XLR-3 connections.	
DI-1804	DMX 8-Way Splitter	Amplifies and splits a DMX signal up to 8 ways. Features 1x male XLR-3 input connection, and 8x female XLR-3 output connections.	
DI-1803	DMX XLR-3 Connector Pair	Utilize this XLR-3 connector pair to create custom length DMX extensions. Sold by the pair (male/female). Male: 2.8 x .71 in. (L x Dia.). Female: 2.4 x .71 in. (L x Dia.)	
DI-1806	XLR-3 to RJ45 Adapter Connector Pair	Converts RJ45 data cables to XLR-3 DMX connections. Sold by the pair (male/female) Male & Female: 2.58 x .87 x .98 in. (L x W x H)	
DI-1809	20 ft. DMX XLR-3 Extension Cable	Creates an extension between DMX fixtures and accessories. Features XLR-3 connections. Wire: 18/3 AWG. Male connection: 2.8 x .71 in. (L x Dia.) Female: 2.4 x .71 in. (L x Dia.)	
DI-1807	RJ45 Coupler	Female-to-female accessory quickly connects two RJ45 accessories. Dimensions: 1.22 x .44 x .87 in. (L x W x H)	
DI-1805	RJ45 Splice Cable	Lead wires connect to wall-mount DMX controllers while RJ45 plug connects to DMX accessories. Dimensions: 6.5 x .4 x .6 (L x W x H)	
DI-1811	XLR-3 to RJ45 Adapter Cable Pair	Converts RJ45 port of 4-Channel DMX Decoder to a standard XLR-3 connection. Sold by the pair (male/female). Dimensions: 20 x .71 (L x Dia)	
DI-1911	RJ45 Extension Cable	Creates a 10 ft. extension between DMX fixtures and accessories utilizing RJ45 connections.	

Note: accessories sold separately

ADDITIONAL RESOURCES

Visit the online product page at www.DiodeLED.com for additional resources including:

- **WET LOCATION LED WALL WASHER Installation Guide**
For system diagrams and full installation instructions.
- **Voltage Drop Charts**
Use to specify appropriate wire gauge for installation. Available at the 'Tools & Resources' page at www.DiodeLED.com.

SAFETY & DISCLOSURES

- Install in accordance with the National Electric Code and local regulations.
- This product is intended to be installed and serviced by a qualified, licensed electrician.
- Do not disassemble or modify this product. Doing so will void your warranty.
- This fixture is not compatible with any traditional dimming controls. Wall washers can only be controlled/dimmed with the on-board interface or with an external DMX controller. Please contact customer service for additional information.
- Ensure all adjusting screws on mounting brackets and fixtures are properly secured prior to permanent installation.
- When mounting to walls and ceilings, use applicable lag bolts and consider the strength of these surfaces versus the weight of the fixture.
- It is recommended to power this fixture by a GFCI protected circuit.
- This fixture is IP65 rated.
- When installing outdoors or in a wet location, ensure water-resistant end caps are connected to all exposed wet location 3-pin M14 connections. If attaching XLR-3 adapter cables seal all XLR-3 DMX connections with 1.25" wide heat shrink and finish with waterproof tape (not included). Do not use liquid sealants of any kind.
- This fixture is not to be used in or around chlorinated, treated or salt water due to the corrosive and degrading qualities of chlorine, saline, and other chemicals on the fixture components. Keep at least 16 feet away from pools and spas.
- Do not install product in an environment outside the listed ambient temperature. Ensure adequate airflow and heatsinking is considered when mounting/installing.
- Operating temperature is measured according to the minimum and maximum ambient temperature environment. Exceeding the maximum ambient temperature may damage LED chips by reducing the total lamp life, lumen output, and/or adversely impact color consistency.
- Ensure adequate airflow and heatsinking is considered when mounting/installing. Exceeding the maximum operating temperature may damage LED chips by reducing the total lamp life, lumen output, and/or adversely impact color consistency.
- Actual color may vary from what is pictured on this sheet and other print materials due to the limitations of photographic processes.
- Lighting technology has some amount of gradual light degradation (output and/or color) over the lifespan of the products. Diode LED products are designed to minimize degradation, but some light degradation and color shift is a normal part of the life span of any LED lighting system.
- We reserve the right to modify and improve the design of our fixtures without prior notice. We cannot guarantee to match existing installed fixtures for subsequent orders or replacements in regards to product appearance, CCT, or lumen output.

WARRANTY INFORMATION

Limited Warranty

This LED fixture has a two (2) year limited warranty from the date of shipment. This warranty does not include the additional accessories referenced in this specification sheet. Complete warranty details for fixtures and additional accessories are available at www.DiodeLED.com under the 'Tools & Resources' tab. For warranty related questions, please contact customer service.

Consumer's Acknowledgment

Diode LED stands behind its products when they are used properly and according to our specifications. By purchasing our products, the purchaser agrees and acknowledges that lighting design, configuration and installation is a complex process, wherein seemingly minor factors or changes in layout and in-field adjustments can have a significant impact on an entire system. Choosing the right components is essential. Diode LED is able to work with the original purchaser to make an appropriate product selection to the extent of the limited information that the customer can provide, but it is virtually impossible for Diode LED to design a system that foresees every unknown factor. For this reason, this Warranty does not cover problems caused by improper design, configuration or installation issues. Any statement from a Diode LED employee or agent regarding a customer's bill of goods and/or purchase order is NOT an acknowledgement that the products purchased are designed and configured correctly. The purchaser agrees and acknowledges that it is the customer's responsibility to adhere strictly to all information contained in the Product Specification Sheets.

There is often more than one way to design, configure and layout an LED lighting application properly to achieve the same lighting effect. Diode LED strongly recommends that licensed professionals be used in the design and installation of lighting systems that include Diode LED products. The specifications include important information that a designer and installer should carefully review and strictly follow. Qualified designers and certified and/or licensed installers, with access to the final installation environment, customer goals, and Diode LED product specifications can make the requisite decisions appropriate for a successful finished lighting application.



Toll Free: 877.817.6028 | Fax: 415.592.1596 | www.DiodeLED.com | info@DiodeLED.com
© 2014 Elemental LED, Inc. All rights reserved. Specifications are subject to change without notice.